

Acoustical Analysis of Initial Transients in Flute Like Instruments

Michèle Castellengo

Laboratoire d'Acoustique Musicale (CNRS; Université Paris 6; Ministère de la Culture) UPMC - case 161, 4 Place Jussieu, 75005 Paris, France

Summary

Time frequency analysis of sounds produced during the initial transients of flute like instruments, (recorders and organ pipes) show that the build-up of the different harmonics of the steady state sounds is preceded by a group of acoustical phenomena – noises, inharmonic tones – which are very important for the perceived quality of the transients. In this paper, initial transients produced by a complete flue pipe instrument (mouth tones) are compared with those produced by the same mouthpiece disconnected from the pipe (edge tones) on several instruments: organ pipes and recorders. Mouth tones from the initial transients of a complete instrument are, just like edge tones, mainly controlled by the mouth parameters: speed of jet at flue exit; and distance between flue exit and labium; they therefore correspond to self-oscillation of the mouth. During pressure build-up and when frequencies coincide, mouth tones can stabilise on one resonant mode of the pipe, creating an inharmonic forerunner which has been observed by many authors. In general, mouth tones, which are due to “mouth behaviour” of the jet, disappear as soon as the regular steady state is established. However, a paradoxical functioning where mouth tones and harmonics of the first mode are coexisting is sought for when voicing a specific organ stop: the viola 4' of the Italian organ. The musical relevance of mouth tones is discussed for the recorder as well as when voicing specific organ stops.

PACS no. 43.75.Ef, 43.75.Np, 43.28.Ra

1. Introduction

This work concerns the spectrographic analysis of initial transients of flue like instruments: recorders, flutes, open and stopped pipes, or any instrument with a flute mouth piece.

1.1. Acoustical analysis of transients

Due to their very short duration and their complexity, initial transients have created difficulties for experimenters. In 1939, Jones [1] published the first analysis of organ pipe transients, obtained by Trendelenburg [2] using a new system of octave band filters which could be successively switched on, the first band ranging from 37.5 to 75 Hz, the last from 4800 to 9600 Hz. The synchronised output signal displayed on a cathodic oscillograph could be recorded on a photographic film using a specially designed moving film camera. Displaying the waveforms from real pipes made it possible to describe the order in which the different harmonics were coming in and the shape under which the sound builds up for different type of pipes. Jones describes as well a special transient which we are going to focus on: analysing the sound from a stopped pipe (Lieblich Gedackt) with fundamental frequency 240 Hz, he saw, at the beginning of the tone, a high frequency vibration located within the octave 1200–2400 Hz, which disappeared as soon as the fundamental started building up. This “forerunner”, according to Jones own wording, has a frequency which is about five and a half time the frequency of the fundamental. It does not belong to the harmonic series of the pipe.

This remarkable observation leads straight off to the following fundamental question: what is the nature of the initial transient of a mouth pipe? A pipe that speaks well, according to the common experience of organ or recorder builders, very often produces high pitch noises quasi-simultaneously with the sound of the main pipe mode. This phenomenon, that creates very quick initial transients, is generally too short for the ear to analyse it really, but did not escape the attention of acousticians who have coined several evocative words to describe it, such as “chiff”, “burst”, “ping” or “spitz”.

However, with the development of new techniques derived from Fourier analysis, researchers focussed on two types of parameters: the order in which each harmonic builds up and the corresponding amplitude rise times, characterizing transients and their durations [3, 4]. In 1972, based on the analysis of 200 organs pipes, Keeler [5] characterized the mean transient time for each family of organ stops: 25 to 30 periods for flutes, 50 periods for the diapason family and more than 40 periods for the string family. The author neither mentioned the origin of the analysed sounds, nor the conditions under which they were recorded.

More recently, Angster and Miklos [6] analysed the modifications of the initial transients as a function of the voicer's work. Indeed, voicers are mainly concerned with mouth parameters. The authors assumed that edge tones play a major rôle in the build-up of the tone from flue like pipes, and that one of the voicer's objectives is to tune the lowest component of the edge tone on the first pipe harmonic. However, the acoustical analysis of organ pipe transients, subsequently presented in different publications [7, 8, 9], only displays the amplitude evolution of the harmonics, mentioning neither noises nor inharmonic sounds notwithstanding any relationship with changes in the edge tones.

1.2. Experiments and models for jet behaviour during transients

In the last twenty years, many theoretical publications have been devoted to sound production in flue like instruments. Some models have even been progressively refined in order to take into account noises and inharmonic sounds. Here are only recalled publications devoted to transients, particularly the works of Fletcher [10, 11], Nolle [12, 13], Nolle and Finch [14], and Verge *et al.* [15, 16, 17].

In his first theoretical publication, Fletcher [10] developed a simplified model for the jet and its interaction with the acoustical field in the pipe, in order to compute the velocity amplitude for the first three pipe modes. He showed that the time evolution of the three modes is a function of the shape of the pressure build-up during the transient. Three types of transient profiles were considered according to the ratio between the mean static pressure (p_0) and the "initial" pressure (p_1) reached after the first 10 milliseconds. In order to obtain reasonable behaviour of transients, Fletcher [10] makes sure that the pressure in the foot builds up quickly above the stationary pressure. He postulates that these types of behaviour are due to interferences between the acoustical waves in the wind supply system. Three classes of transients are analysed: "plosive" for $p_1 \gg p_0$, "abrupt" for $p_1 = p_0$ and "slow" for $p_1 \ll p_0$. For "plosive" transients, the model produces initial predominance of the second mode during the first 150 ms, the three modes remaining inharmonic. Fletcher considered this class of transient as a possible explanation for the "chiff" of organ pipes.

In a second paper [11], Fletcher returns to on this interpretation. The paper modelises the emission of the three first modes of a pipe under steadily increasing pressure. Computations are compared with measurements carried out on an adjustable pipe with variable mouth cut-up and flue width. The model makes it possible to predict the pipe transients under several regimes: Underblown, Normal, and Overblown. Fletcher further suggests that the characteristic "chiff" of baroque organ pipes is closely related to the Underblown regime.

As far back as 1941, Nolle studied the initial transients of 28 real organ pipes using global oscillograms without filtering. He analysed the time characteristics of the transients as a function of the fundamental frequencies for different families of stops: bourdon, flute, diapason and string. He observed tones that are slightly inharmonic in the transients of the bourdon and flute families, yet admitting that the frequencies of such transients could not be measured precisely.

In 1979, Nolle published a series of experiences made with a pipe specially designed to allow fine and accurate adjustments of the main geometrical parameters: mouth parameters, such as mouth height, flue thickness, position of the labium with respect to the flue as well as pipe parameters, such as the overall length, and whether the pipe is open or closed. The cross section of the pipe could either be cylindrical or rectangular. The air supply, controlled by a pallet placed below the foot, provided for reproducible transients of the "abrupt" type. The variations in sound quality due to mod-

ifications of mouth heights and jet directions are described with the help of adjectives and onomatopoeia. In the domain where the pipe speaks well, Nolle identifies two types of transients. "ping" transients, also called xylophon-type, correspond to quasi-periodic oscillation, close to the third or the fifth harmonic (stopped-pipe). "chiff" transients sounds like noise bands with pitches close to the same harmonics. The author also analyses a "ping" transient by Fourier analysis of the sampled signal. Several sound phenomena related to edge tones are also described but they are not set in relation with the two above mentioned transients (ping and chiff).

In their 1992's publication, Nolle and Finch present a systematic experimental analysis of the variations of the attack transients when the pressure rise time varies in the pipe. All the experiments are carried out on the adjustable pipe described above. The wind supply system, specifically built for the experiments, allows reproducible pressure rise profiles. A wind note channel with pallet is also used for very short transients. For each experiment, the authors give the pressure curves measured in the foot, the sound wave signals, and in some cases the rising curves for the amplitude of the fundamental and the third harmonic of the pipe.

In his description of attack transients, Nolle distinguishes between two types of events: the "forerunner", a high frequency inharmonic tone; and a "burst", generally corresponding to a sudden rise of amplitude for the second mode of the pipe, immediately before the fundamental builds up (Next Mode Burst). The burst, therefore, generally concerns the second harmonic of an open pipe, or the third harmonic of a closed pipe. But it is not clear whether it is an harmonic, because, as the authors say, "The component that evolves into the second or third harmonic is often sharp in the early stages. Even so, the signal components will be called harmonics for convenience" (p. 2192). In fact, only sounds of type Next Mode Burst are taken into account in the model for describing and simulating the attack transient. The nature and the rôle of the forerunner are subjected to hypotheses which will be discussed below (Section 4.2).

Nolle concludes that the shape of the pressure rise determines both the build-up time of the sound, and the content of the transient in initial sounds. Taking as reference the rising time corresponding to the full build-up of the fundamental, t_{bf} , about 10 periods for his pipe, he distinguishes between "slow" rising times (longer than 10 periods) and "fast" rising times (less than 10 periods). "Abrupt" rise time (about one period of the fundamental) is considered as a particular case in which impulsive excitation of the resonator is taking place. The forerunner and the Next Mode Burst are strongest for fast rises (neither abrupt nor slow) extending typically from 1 to 10 periods of the fundamental. The emission, at the frequency of mode 1, of an external loud tone in front of the mouth (producing an internal pressure of about 10% of the pressure in the pipe under normal functioning), gives rise to two interesting results: a faster build-up of the fundamental (20 ms); and a cancellation of initial sounds.

Nolle suggests that the forerunner is due to the excitation of a transverse mode of the pipe. However, the importance of the side walls for edge tones, has been shown by Powell [18].

Therefore, even if the transverse resonance is not excited, side walls do influence the oscillation if the forerunner is an edge tone.

Later, Nolle developed a theoretical model restricted to oscillations corresponding to the resonator modes, thus excluding the forerunner. This model explains how the pipe is set into oscillations by pressure variations in the attack transients, and convincingly reproduces transient shapes similar to those observed, that is, presenting bursts at experimentally observed pressure variations.

The works of Fletcher and Nolle¹ concern organ pipes for which the ratio of the flue labium distance (w) to the jet thickness (h) is about 10. In this configuration, higher hydrodynamic modes are obtained in steady state. These modes are responsible for the coming back of sounds at the end of notes, when the pressure falls in the wind supply. Recent visualisations by Yoshikawa [19] have proved that these modes also create Next Mode Burst tones during the attack transients. For recorders, builders choose a ratio w/h of 4 which rejects the higher hydrodynamic modes. Fletcher's jet model [11] cannot take into account non-linear saturation (whirl formation) which characterises jet oscillations in higher hydrodynamic modes. All models over-estimate these modes.

Hirschberg and his collaborators have contributed to a better description of the transient phenomena by introducing visualisation techniques. Their experimental pipe, with square cross section, has the same dimensions as the one foot diapason, and a mouth similar to one of a recorder. The mouthpiece is simplified for the sake of visualisation and the chamfers at the flue exit are replaced by right angles 90° wedges. Thanks to these visualisations, Mahu and al. [20] and Verge [16] could explain the main differences measured during very short (2 ms) and very soft (20 ms) attack transients. More recently, the sound synthesis model developed by Verge accounts for jet oscillation, whirl separations at the wedges, and turbulences in the mouth. For recorders, this model gives, for different pressure rises, signals that are very similar to the signals recorded on a real instrument [16, 17, 21]. However, the jet model used by Verge [17] is similar to Fletcher's [11]: it cannot properly describe the attack transients of organ pipes.

1.3. Remarks

At this point, it is necessary to make the following remarks. Except for Angster's work [9], realised together with organ builders, recent acoustical studies on transient sounds lay upon a small number of experiments which generally are not representative of musical reality, although they are very accurately carried out. The pipe used by Fletcher [11] does not display the famous "chiff". The organ pipe used by Nolle [13, 14] is adjustable so that its length can be modified, and can be played as a bourdon or as an open pipe, making it possible to experimentally study the influence of modal harmonicity on attack transients. It is well known however, that changing the scale or the functioning mode (open or closed), requires adapting the mouth differently so that the

pipe speaks properly. Transients displayed for different adjustments of the pipe cannot therefore be compared because the mouth has been changed each time. And the experimental organ pipe used by Hirschberg for visualising the jet presents sharp edges, in order to simplify the description of the flow. Such an instrument is far from being realistic for musical use.

Secondly, the works of Fletcher, Nolle and Verge quoted above do not display time/frequency analysis of the attack transients. Neither the precise frequencies nor the time evolution is given for sounds designated by such words as "fore-runner, ping, chiff, burst". Their description is most often simplified: high pitched tone, higher harmonics (2nd or 3rd). In fact, the waveforms of the acoustic signals they used are driven predominantly by the first two harmonics which prove strongest. In linear amplitude scales, the forerunner component, which displays a very low level, is compressed, and scarcely distinguishable from the background noise. Last but not least, the sound "quality" of the attack transients, and whether they are representative or not of an actual adjustment by a voicer for musical use, are rarely indicated.

The present work proceeds along a different line, inasmuch as the framework proposed for describing the acoustical phenomena that take place during the transients has slowly emerged from listening and analysing the sounds of musical instruments of acknowledged quality. It aims at accounting for the perceptive characteristics of these sounds. For many years, the author has practised several flutes, both recorders and transverse flutes, has tried instruments from different builders, and has also worked together with organ builders when voicing flue organ pipes according to different sound aesthetics. Experience has shown that "mouth sounds", which are produced during the attack transients, are of paramount importance when judging sound quality. Therefore, an analysis technique is required that can very accurately describe mouth sounds. Time/frequency spectrography of the Sona-Graph type, developed for speech analysis, where acoustical information is principally contained in transients, has proved best suited to analysing musical transients [22, 23]. Moreover, an experimental technique, developed earlier for flue type pipes [24], in order to separately analyse the sounds produced by the mouthpiece of a given instrument, has been systematically applied to compare the spectrographic contents of the attack transients of the mouthpiece alone, to those of the whole instrument.

All analyses of transient phenomena in flue pipes put forward in this paper are based on systematic experimentations where each parameter variation has been studied by time frequency/analysis of the corresponding sound signals.

2. Experimental method

2.1. Spectrography of attack transients

As already mentioned, the sound waveforms analysed by Nolle and Finch [14] or Verge *et al.* [16, 17, 21], suffer from a major drawback: they give most weight to high amplitude

¹ A. Hirschberg, personal communication.

Table I. Instrument data given in mm.

Organ pipe	No1	No2
Material	Metal	Metal
Internal diameter	D = 28	D = 26
Pipe length	L = 291	L = 225,5
Scale	L/D = 10 (Principal)	L/D = 9 (Principal)
Wall thickness	0,5	0,7
Foot length	219	180
Mouth dimensions	1×h = 20,5×5	1×h = 20×4
Flue width	<0,5	<0,5
Alto recorder	No1	No2
Material	Plastic	Wood
Trade mark	Rahma	Aura, baroque syst.
Internal diameter of mouthpiece	D = 18,2	D = 17,5
Wall thickness of mouthpiece	7	
Mouth dimensions	1×h = 12×4	1×h = 11×4
Duct length	59	55
Input section of duct	12×2	12,8×2,2
Output section of duct	12×0,75 (flue exit)	11×0,85 (flue exit)

components that mask simultaneous high frequency components with lower amplitudes. However, these last components can be predominant for the human ear, which is mostly listening to very short and quickly changing phenomena, especially if their frequencies falls within the area of high sensitivity (3000 Hz). To illustrate this point, the first experiment compares the waveform of an attack transient with its narrowband spectrographic analysis that gives the same weight to each signal component, be they harmonic or not, and makes it possible to follow the time evolution of each of them separately.

Let us take a cylindrical organ pipe made of tin, with a conical foot (dimensions given in Table I). The pipe is played through a device similar to a small organ and comprising a blower, a regulator system, and a traditionnal wind tank (0.3 m³) connected to a small chest. The last contains a parallelepipedic channel (10×75×250 mm³) with a rectangular pallet and a mechanical actuator that allows a wide range of reproducible attacks. Static pressures are measured with a piezoelectric sensor "microswitch" (176 pc 14 HG 1) ranging from 0 to 3435 Pa. The cut-off frequency of the sensor measuring bridge amplifier system is 1 kHz. The sensor is connected to the cavity inside the foot by a flexible tube of diameter 1.25 mm. An electrodynamic directional microphone stands 25 cm in front of the mouth opening and records the sound of the pipe.

The outputs of the pressure sensor and the microphone are connected to the two channels of a digital FFT analyser (Sona-Graph/DSP 5500 from Kay Elemetrics) so that simultaneous analysis of the two signals can be carried out.

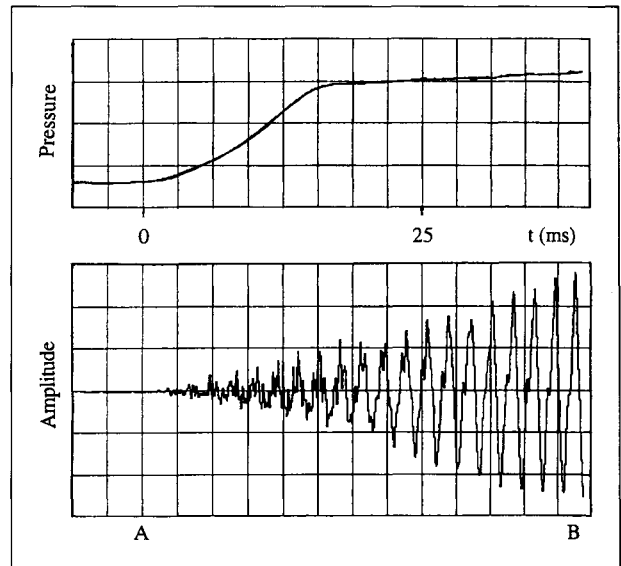

Figure 1. Organ pipe No1, attack transient. a) pressure in the foot-pipe; b) sound waveform.

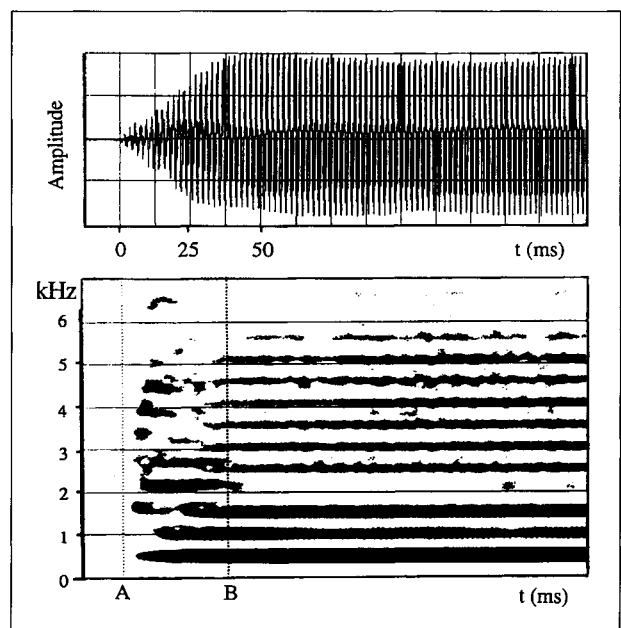

Figure 2. Same sound as Figure 1 with different time scale. a) waveform; b) time frequency analysis (sonagram).

Figure 1 shows: a) the shape of the pressure rise in the foot of the pipe; and b) the microphone signal. High frequency phenomena can be seen at the very beginning of the signal as well as during the first periods of the fundamental. Between points A and B, the transient lasts about 40 ms (20 periods).

Figure 2 gives a longer excerpt from the same transient. Curve a) shows the sound waveform, and curve b) its time frequency/analysis² with intensity indicated by line shade

² Technical data for Figure 2: sample frequency = 20.48 kHz; transform size = 200 pts or 9.76 ms; overlap = 25; samples per pixel = 8

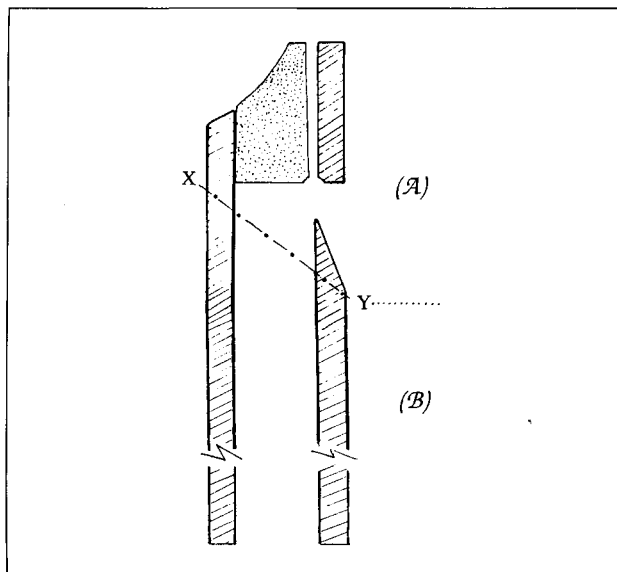

Figure 3. Sketch of the experimental recorder. The mouth (\mathcal{A}) can be disconnected from the resonator (\mathcal{B}) along the broken line XY. Part (\mathcal{A}) alone constitutes an air jet labium system.

width. The harmonics of the steady sound are labelled according to their order on the right hand side of the Figure. The cursors A and B delineate the time segment displayed in Figure 1.

Figure 2b makes it possible to quickly grasp the nature of the high frequency events which are visible on the waveform of Figure 1b. The beginning of the transient is dominated by a rapid succession of very short components with ascending frequency reaching up to 4500 Hz (between H8 and H9), among which a more stable frequency with non negligible intensity can be noticed around harmonic H4. These components, which appear during the rise time of the fundamental, last about 30 ms and then vanish.

This is not a particular case. Having analysed in this way a very large number of attack transients from organ pipes and recorders, we can assert that time/frequency contents of transients are often very complex, vary extremely from one attack to the other, and can be neither reduced to only one forerunner nor to amplitude "bursts" of the 2nd or 3rd harmonic.

The next experiments will show that the quick frequency variations of the sounds appearing during transients give valuable information on the mechanisms that are taking place during sound build-up.

2.2. Acoustical analysis of attack transients for a recorder: mouth tones and edge tones

A standard manufactured alto recorder was carefully cut along line XY (Figure 3), in such a way that the rear wall of the recorder, cut just above the cork, is taken away while the labium of the instrument is kept unaltered for jet production. The upper part (\mathcal{A}) of the mouthpiece thus isolated is an air-jet/labium system. The pipe itself (\mathcal{B}) consists of the rest of the mouthpiece, the body and the foot of the recorder.

It is therefore possible to play either (\mathcal{A}) alone or the whole recorder by joining together ($\mathcal{A} + \mathcal{B}$). The whole system is made airtight by use of modelling clay. The dimensions of the mouthpiece and the characteristics of the instrument are given in Table I.

The recorder is then set on the organ system described above, in order to ensure reproducible excitation. The output signal of the pressure sensor fixed on the air supply pipe to the mouth and the signal from the microphone placed 25 cm in front of the mouth are recorded simultaneously and analysed under the same conditions. For a given fingering and for a given static pressure in the air tank, the whole recorder ($\mathcal{A} + \mathcal{B}$), and only part (\mathcal{A}) are successively played using the same time pressure profile for the attack.

The sound signal recorded by the microphone is presented in Figure 4 according to two representations: waveform in the upper part and sonographic time/frequency analysis in the lower part. Look first at the attack transient of the tone produced by the whole flute ($\mathcal{A} + \mathcal{B}$), in the lower part of Figure 4a. The time/frequency analysis, which cuts off at 8 kHz, displays the building up of the first 9 harmonics. The fundamental, by far the most intense, sets up before all the others. It is preceded in time (25 ms) by a very high pitch tone, with ascending component developing between 4 and 5 kHz. Look now at the analysis of the sound produced by part (\mathcal{A}) only (Figure 4b). The time/frequency analysis displays only one component that stabilises around 5 kHz after a transient lasting 25 ms and presenting a frequency evolution similar to the evolution of the high pitch forerunner in Figure 4a. When comparing waveforms in the two Figures, the waveform of the whole recorder ($\mathcal{A} + \mathcal{B}$) presents in its 12 first milliseconds an amplitude similar to that produced by part (\mathcal{A}) alone. With reference to this example, let us now define the terms used in the rest of the paper for describing the different states of typical flue pipe transients.

2.3. Definitions

The recorder was cut in two pieces so that part (\mathcal{A}) only consists of a air-jet/labium system. As is well known, such a system produces tones with frequencies that increase monotonically with air supply pressure. Such a system also displays several functioning regimes and can jump more or less arbitrarily from one regime to another [25, 26, 24, 27]. The frequencies of the tones produced by part (\mathcal{A}) of the recorder have been systematically measured, the mouth being connected to a compressed air container through a regulator. Figure 5 displays the frequencies obtained for supply pressures in the interval 100 to 900 Pa. Results are similar to what is obtained with a classical air-jet/labium system: all points line up on the first three hydrodynamic modes, called "mouth graphs" by Bouasse. Mouth tones can also be analysed sonographically (see the right hand side of Figure 14). The latter representation has several advantages: it gives an indication of intensity; it makes it possible to appreciate the spectral content, especially for noises; and last but not least, it allows for an immediate comparison with transient tones under the

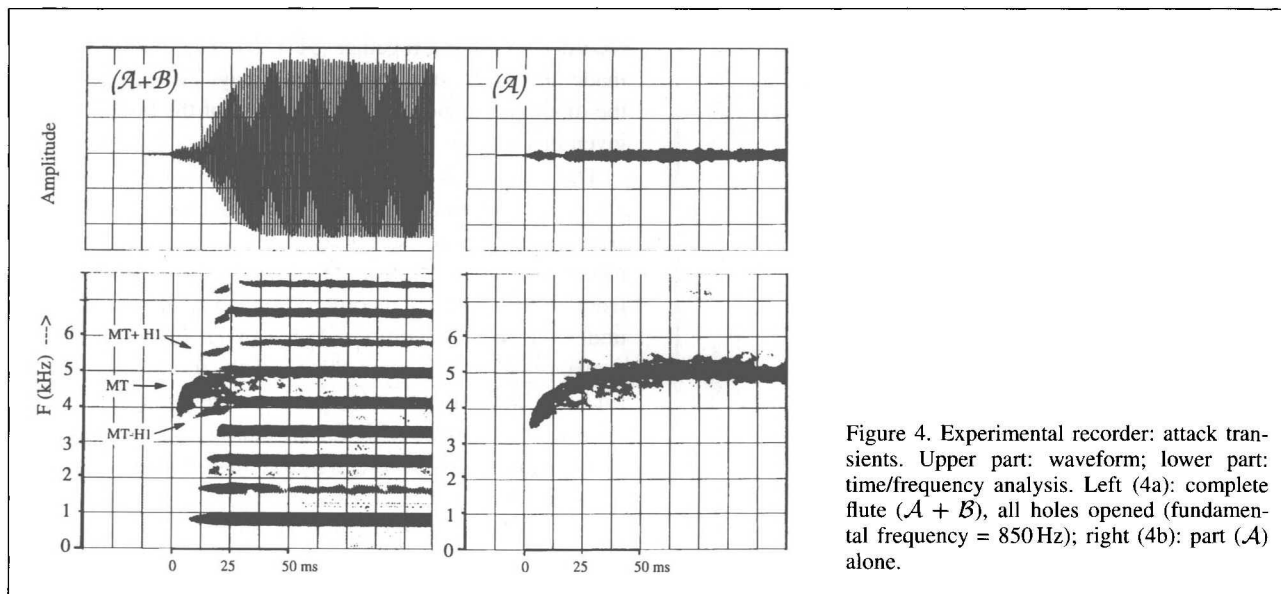

Figure 4. Experimental recorder: attack transients. Upper part: waveform; lower part: time/frequency analysis. Left (4a): complete flute ($\mathcal{A} + \mathcal{B}$), all holes opened (fundamental frequency = 850 Hz); right (4b): part (\mathcal{A}) alone.

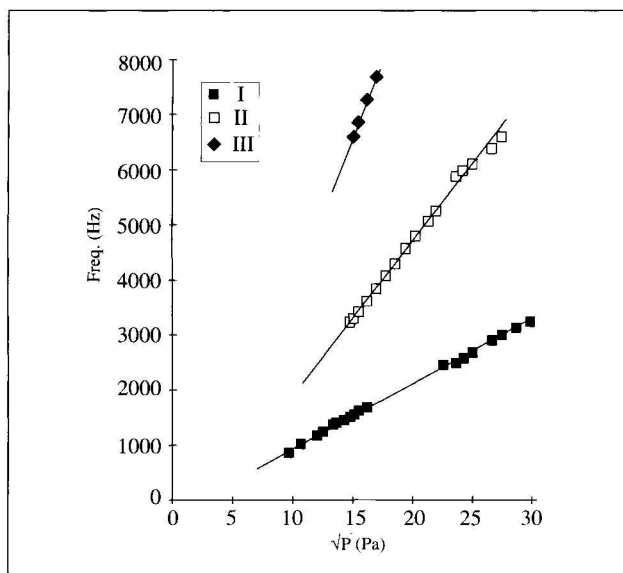

Figure 5. Experimental recorder. "Mouth graphs" produced by part (\mathcal{A}) only. The symbols correspond to experimental data, and curves I, II, III to the different hydrodynamics modes.

same representation. *Tones produced by part (\mathcal{A}) alone will be called edge tones.*

Considering now the whole recorder ($\mathcal{A} + \mathcal{B}$), what is usually called the attack transient corresponds to the building up of a stable regime in the pipe. Its time limits are not easy to define, but it is usual to take the amplitude maximum of the time signal as the end of the transient. In the example of Figure 4a, one can estimate the transient duration to be about 30 ms. Complete acoustical description must therefore take into account all phenomena that take place before the last harmonics have appeared. *Tones that do not belong to the harmonic series of the fundamental and take place during the attack transient of the whole recorder ($\mathcal{A} + \mathcal{B}$) shall be called mouth tones.*

From Figure 4, it is obvious that the mouth tone spectrum is more complex than the edgetones spectrum of part (\mathcal{A}) alone. Detailed analysis shows that several tones visible in the mouth tones are *difference* tones. Great care has been taken to check that it is not an artefact from the microphone or the analyser, nor due to overload in the analysis system. The difference tones are reproducible and can be observed with different analysis techniques³. In Figure 4, the main mouth tone (MT) is lined with side-bands which are not harmonics: most conspicuous are the two main side bands (MT+H1 et MT-H1) which appear as the fundamental of the pipe is setting up (see [28, 29] for more examples). Though generally very short lived, difference tones are of paramount importance in cases where mouth tones keep on during the whole sound emission of the pipe. Such difference tones, generally considered as defects the organ builder should correct, are sometimes deliberately produced for musical purposes, as shall be seen in section 3.3, when analysing the *viola 4'* stop in the Italian organ.

The experiments presented so far can be reproduced at will with different flue pipes. In order to avoid destroying valuable instruments, one can use a well known technique to cancel the pipe reaction. The technique sounds very simple, but really is quite tricky, because the pipe must be filled up with soft materials (strips of linen, or cotton wool) in order to absorb the acoustical vibrations that take place in it without perturbing the building up of the jet. With a bit of practice, the technique can be sufficiently well mastered and, since

³ Digital signal analysis does not create combination tones as was common with former analog analysis. For example, when analysing the sound produced simultaneously by the same player, with two flutes, the Sona-Graph KAY elemetrics 7029A used to display combination tones similar to the one produced inside the human ear. Such combination tones are no longer visible on the digital Sona-Graph DSP 5500. However, combination tones produced by attack transient are still visible and must therefore correspond to non-linearities in the source itself.

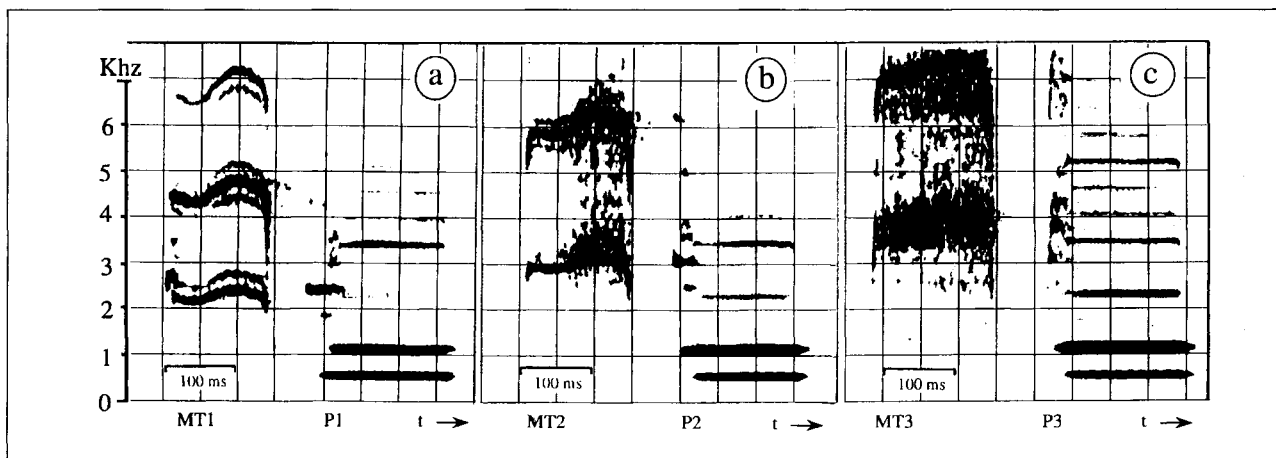

Figure 6. Organ pipe No2 - Comparison between sounds produced by the mouth alone (MT) and sounds produced by the whole pipe (P) for three different supply pressures. Left, $P = 255$ Pa; middle, $P = 441$ Pa; right $P = 657$ Pa. Time scale: 50 ms per division.

it is reversible, it is easy to check its reproducibility at any time. It has been used for the whole recorder ($A + B$) studied above, in order to check the possibility of obtaining edge tones without cutting the instrument in two.

With reference to Figure 4, we postulate that mouth tones present in attack transients are related to edge tones produced by mouth pieces alone. In order to enrich the discussion, several experiments are now presented where tones produced by the air-jet/labium alone are systematically compared to tones produced by the whole flue like instrument.

3. Experimental results

3.1. Variation of transient mouth tones with static pressure

A second organ pipe of average scale (Table I, Pipe no2) is now set on the small organ. The supply pressure measured in the note channel is set at three different values: 26, 45 and 67 mm of water (respectively 255, 441, and 657 Pa). For each static pressure, the tones produced by the mouth only (pipe filled up with absorbing material), and the tones from the normal pipe are successively recorded. The channel pallet is triggered in a reproducible fashion. Spectrographic analysis of the tones thus obtained are given in Figure 6 where are presented side by side the tone from the mouthpiece alone (MT) and the tone from the full pipe (P) for all three supply pressures. Look first at the harmonic content of the pipe tones when pressure increases: the tones become fuller and more intense, the amplitude of the second harmonic increases, and for $P = 657$ Pa the pipe is nearly overblowing. Attack transients on the other hand contain mouth tones with frequencies and spectral complexities increasing with pressure. When comparing the mouth tones present in the pipe transients with the corresponding edge tones for each pressure value, one notices some similarities. In particular, the frequency of the most prominent mouth tone, (2300 Hz for the pipe P1, 3000 Hz for P2 and 3800 Hz for P3) corresponds to the fundamental of each of the tones produced by the mouthpiece alone.

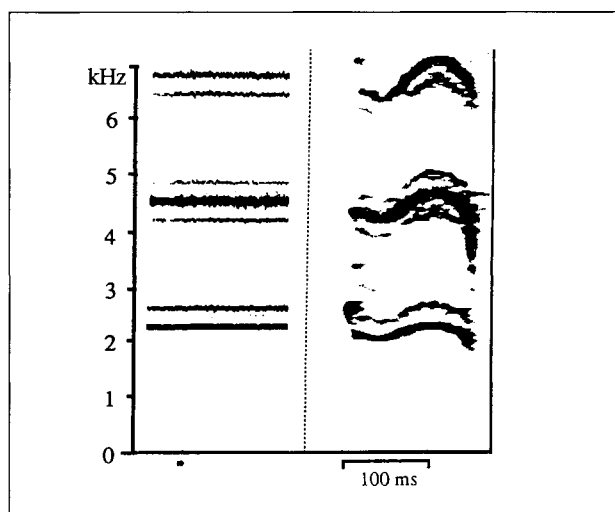

Figure 7. Organ pipe No2 - Time/frequency analysis of sounds produced by the mouth disconnected from the pipe. $P = 255$ Pa. Left: compressed air from a container, directly connected to the foot of the pipe; right: compressed air from windchest, through note channel and pallet. Notice the sensitivity of the mouth tone frequencies to small pressure variations in the note channel.

Since edge tones are extremely sensitive to pressure variations, the frequency variations visible on Figure 6 need to be explained. Figure 7 presents on the left, the steady state part of the sound produced by the mouthpiece alone (Pipe No2) under constant supply pressure (255 Pa) delivered by a compressed air container through a regulator, and on the right, the same sound produced by the experimental organ taken from Figure 6a. It is clear that the frequency variations of the mouth tones in Figure 6 are due to small pressure oscillations, produced in the chest of the experimental organ (about 30 Pa). When the pallet opens, the pressure falls slightly, and the note channel, a mass/spring system with one degree of freedom, is set into oscillations. Such oscillations have been systematically studied [30, 31]. Although these low amplitude oscillations (about 10% of the pressure value)

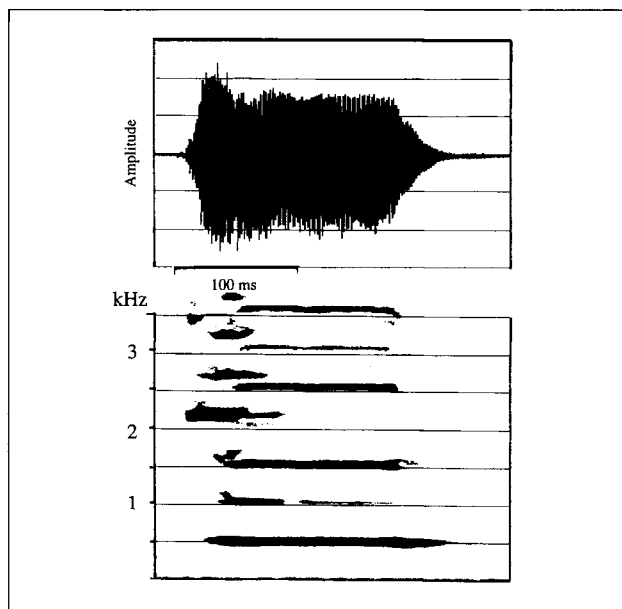

Figure 8. Organ pipe No. 1, attack transient: waveform and time/frequency analysis.

have negligible influence on the steady state fundamental frequency of the pipe, they considerably alter the frequencies of edge tones, especially in the case of repeated notes. Moreover, in Figure 6, and more precisely in tones MT1 and MT2, glissandi take place when the pallet is closing, and in tone MT3, two initial ascending glissandi can also be seen in the transient mouth tone P3. These variations follow the rise and fall of pressure in the pipe foot when the pallet is moving.

We hope that the reader is now convinced of the extreme spectral complexity of the sounds produced by the mouthpiece of this organ pipe. Many components are present, some of which are inharmonic. Experience has proved this to happen in organs for all metal pipes, with a mouth geometry markedly different from that of wood pipes. For metal organ pipes like the present one, the role played by the resonances of the foot cavity in the spectra of the sounds produced by the mouthpiece only has been demonstrated elsewhere [24].

Experiments similar to the present one with organ pipe No2, have been reproduced many times in our laboratory with pipes of different scales and dimensions. At this point two observations need to be emphasized, namely

1. the existence of mouth tones with frequency variations controlled by mouth parameters;
2. the one to one correspondence between edge tones and mouth tones.

The last observation suggests a functioning of the exciting system that may seem paradoxical, but only because the time domain approach to transients is not widely accepted in musical acoustics, unlike room acoustics: during the transients, the mouth first speaks in a quasi-self sustained way; then, later on, the pipe starts reacting. This will now be shown in detail.

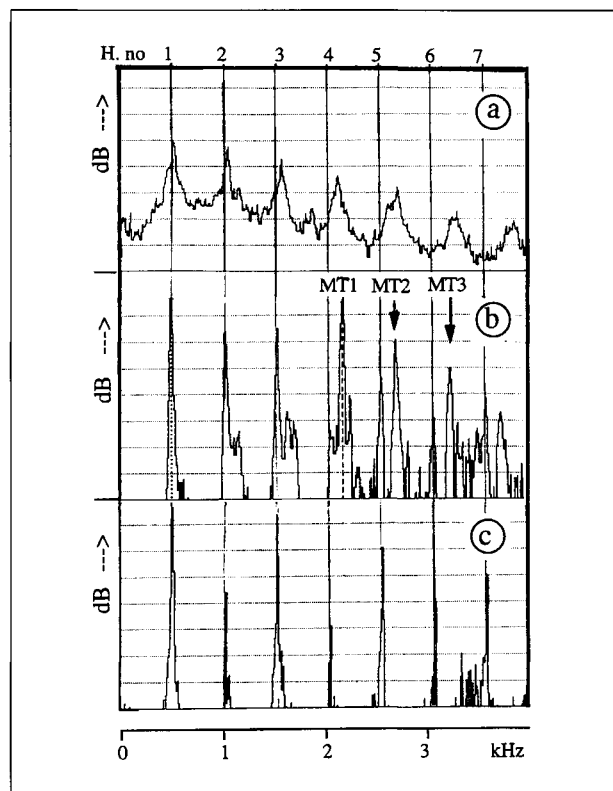

Figure 9. Organ pipe No1, spectra. Linear frequencies, 0–4000 Hz; horizontal lines 9 dB apart. Vertical lines indicate the harmonics of the steady state regime (fundamental frequency = 513 Hz). a) Noise excitation, average spectrum displaying the passive resonances of the pipe. b) Attack transient spectrum computed over time window A-B in Figure 8. c) Steady state spectrum.

3.2. Influence of pipe eigenmodes on mouth tones during attack transients

In his analysis of transients of stopped organ pipes, Jones indicates that the “forerunner” is a tone that does not belong to the harmonic series of the pipe, and which has a frequency roughly $5 \frac{1}{2}$ times the fundamental frequency. The preceding analysis (Figure 6) also showed the inharmonicity of mouth tones. In the many transients of organ pipes and recorders we have analysed [24], the dominant frequencies of the mouth tones were always very close to the eigenmodes of the pipes. The following experience specifies the later observation.

Figure 8 shows a tone produced with pipe No1 (fundamental frequency 513 Hz, see Table I): waveform in the upper part and time/frequency display in the lower part. The first sound in the transient, also called “forerunner”, has a frequency of 2170 Hz, slightly above the 4th harmonic of the pipe (2052 Hz). Notice, as often is the case, that the harmonic closest to the most prominent mouth tone has a low intensity.

Figure 9 presents three spectra, still pertaining to pipe No1. The vertical harmonic grid used for frequency reference is taken from Figure 9c, that is, from the steady state part of the sound, 120 ms after the onset. The eigenmodes are measured with white noise excitation, averaging the spectrum over a long time [1 second] (Figure 9a). A second resonance

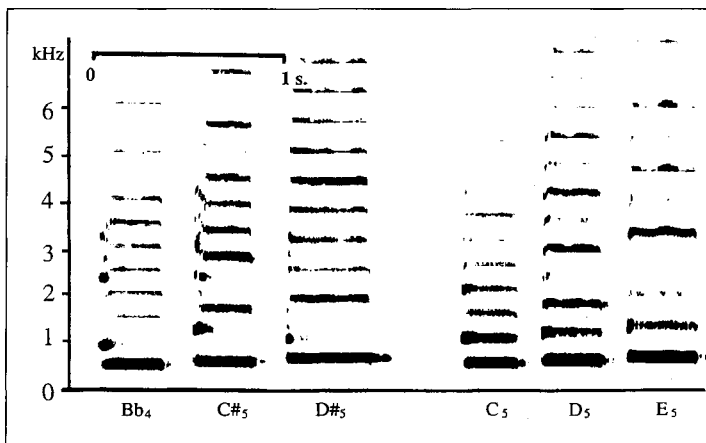

Figure 10. Alto recorder No2 - Time/frequency analysis of staccato notes: a) fork fingerings Bb, C#, D#; b) regular fingerings C, D, E. Mouth tones are more numerous and stronger for fork fingerings.

Table II. Frequencies of mouth tones and resonant modes for Organ pipe No1.

Rank order	1	2	3	4	5	6
Harmonic series	513	1026	1539	2052	2570	3080
Resonant modes (sinus excitation)	504.5	1044	1576	2130	2700	3270
Resonant modes (noise excitation)	515	1050	1580	2140	2720	
Mouth tones				2170	2710	3250

measurement with sinusoidal excitation gave very similar results. Spectrum 9b is computed over the first 100ms of the attack transient (segment indicated in Figure 8). It therefore displays both the harmonics of the building up sound and the mouth tones components. Clearly, mouth tones M1, M2 and M3 are very close to modes 4, 5 and 6 of the pipe respectively. Numerical values are given in Table II. Increasing the damping of the eigenmodes of the pipe, for example by covering the internal wall of the tube with an absorbing material without changing the mouth, only attenuates the mouth tones but does not change their frequency contents [24].

On a recorder or a one-keyed flute, tones produced with fork fingering are especially rich in mouth tones. Due to modal inharmonicity, the steady state tones are lacking in harmonics, but the attacks present mouth tones much more intense and more stable than those obtained for fingerings without forks. Figure 10 compares attack transients for forking tones (left), to those for regular fingerings (right): the former contain more developed mouth tones. The instrument is an alto recorder played with "Te" type attack. It can easily be shown that the mouth tone frequencies for these fork fingerings correspond to the modes of the pipe, particularly inharmonic for these fingerings. As a matter of fact, such fingerings do easily produce multiphonic sounds by keeping

up two or three modes. The same observation can be made in organs for chimney pipe, that usually display inharmonic resonant modes. For that type of pipes, the art of the organ voicer seems to consist in adjusting the attack so that the mouth tones catch the 3rd partial (close to the 5th harmonic). More on transient attacks for chimney organ pipes is given in Section 5.2.

To sum up, during the pressure rise time of the transients, mouth tones frequencies may temporarily stabilize on passive resonances of the pipe, producing tones with well defined frequencies.

3.3. Persisting mouth tones during normal pipe regime

Mouth tones which are too intensive and too stable can perturbate the normal functioning of a pipe. As organ builders say, the pipe "sizzles" (in French: grésille), one hears 'bees'. Several remedies are used which usually consist in rounding off the edges of the flue exit with very fine sand paper, or to make small nicks in the flue. In some cases, the correct adjustment of a pipe may precisely correspond to the special effect of very high pitch inharmonic mouth tones coexisting with the periodic regime of the first mode. Such an aesthetic conception can be heard on very thin scaled pipes from e.g. the *salicional* or *gamba* stops.

The example displayed in Figure 11 is taken from the viola 4' stop, bass register from an Italian organ made by Serassi (1807) [32]. The first two notes of a descending scale, B4 = 488.2 Hz and Bb4 = 459.7 Hz, recorded in the church of Tende (France) in 1989, are displayed. Figure 11 shows that these two sounds have complex spectra with many high rank spectral components, some of which are very intense in the 3 to 4 kHz range where the human ear is particularly sensitive. From the 4th component upwards, spectral lines look like being split in two. For both notes, the spectra averaged on the whole duration are plotted in Figure 12 where the vertical grid strictly corresponds to the harmonic series of the fundamental frequency of each pipe. The two spectra are strikingly similar. The first harmonics are clearly aligned on the grid, but as the rank increases, higher pitch lateral lines appear that increase in intensity until they eventually supplant the harmonics of the fundamental. The higher halves of the spectra consist

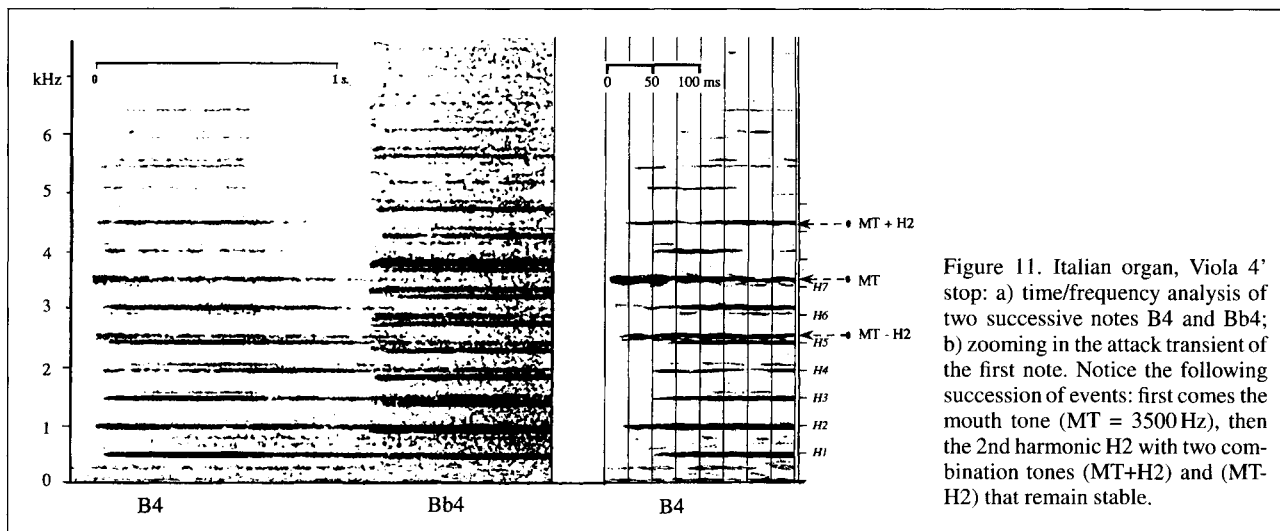

in inharmonic components. Zooming on the transient of the first note B4 (Figure 11b) reveals that the forerunner is the most intense component of this inharmonic series, MT1 = 3500 Hz. Afterwards come the second harmonic and two difference tones (MT1 + H2) and (MT2 - H2) simultaneously. They give rise to a transposed inharmonic series, analysed in Figure 12, which is made of difference tones created by a combination of the main mouth tone and the harmonics of the fundamental. Listening to this inharmonic sounds gives a very special sensation, quasi metallic and slightly grating. For notes B4 and Bb4, the mouth tones stabilize on the 7th and the 8th modes of the pipe respectively.

3.4. Variations of attack transients with pressure rise slopes

The experiment was carried out on alto recorder No1 played through the small organ chest in order to obtain a specified constant pressure. The pallet was activated manually. The upper half of Figure 13 displays the pressure rises and the sonagram analysis of the corresponding tones. The lower half zooms in on the very transients with the sound waveform and its sonographic analysis⁴. Pressure build-ups are from left to right 50 ms, 30 ms and 15 ms respectively. These amount to 43.5 periods of the fundamental for the slow transient, 26 for the intermediate transient and 13 for the fast transient. The rise times of the corresponding sounds do not follow the same progression. The longest transient when listening corresponds to Figure 13b with an intermediate pressure rise time: the mouth tone takes such an importance that it delays the onset of the fundamental. Therefore, there is no simple relation between pressure rise time in the foot and attack transient duration for a mouth pipe.

⁴ Technical data for Figure 13. Sample frequency 20.48 kHz. Upper part: transform size = 200 pts or 9.6 ms ($\Delta f=150$ Hz); overlap = 25; sample per pixel = 8. Lower part: transform size = 128 pts or 6,25 ms ($\Delta f=234$ Hz). overlap = 64; sample per pixel = 2.

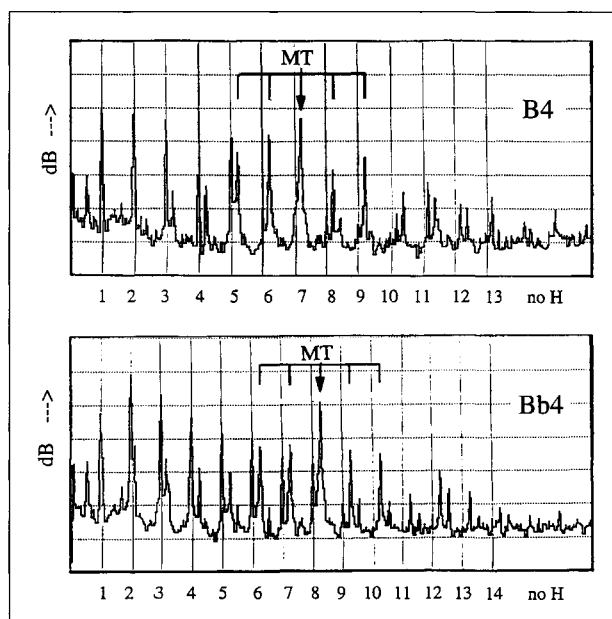

4. Discussion

4.1. The present experimental results

The acoustical analysis of organ and recorder sounds with good musical quality has shown the existence of mouth tones preceding the onset of the steady tone harmonics. Basically, two experimental techniques were used: fine resolution time/frequency analysis of transient signals; and systematic comparison between the sounds produced by the jet/labium system of the mouth disconnected from the pipe and the sound produced by the whole flue pipe under regular functioning. The following observations were made:

1. Under the same conditions of pressure supply, edge tones produced by the mouth only and transient mouth tones

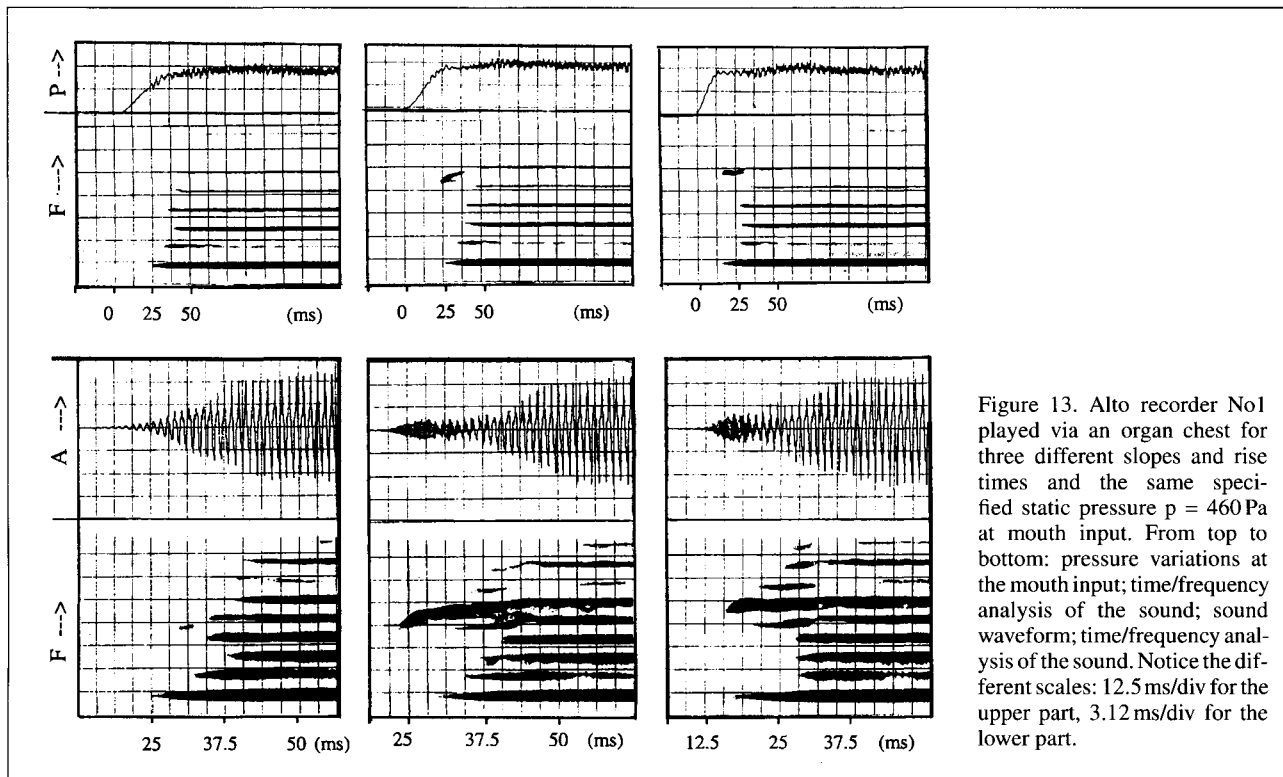

Figure 13. Alto recorder No1 played via an organ chest for three different slopes and rise times and the same specified static pressure $p = 460$ Pa at mouth input. From top to bottom: pressure variations at the mouth input; time/frequency analysis of the sound; sound waveform; time/frequency analysis of the sound. Notice the different scales: 12.5 ms/div for the upper part, 3.12 ms/div for the lower part.

produced by the whole pipe are similar. As a consequence, mouth tones of attack transients of flue pipes are, like edge tones, controlled by the two main mouth parameters: the jet velocity at the flue exit, and the flue/labium distance.

2. Mouth tones are produced before the onset of the pipe harmonics. In other words, during the attack transient, the regular steady state modes of a flue pipe only come after a completely different regime, the latter being under the sole control of the mouth.
3. The spectra of mouth tones have great variety and usually contain several frequencies. More complex mouth tones were obtained for organ pipes than for recorders.
4. For a given instrument, mouth tones are extremely dependent on the supply pressure, just like edge tones. In order to compare attack transients, it is therefore extremely important to precisely control not only the pressure rise time but also the precise shape of the pressure rise at the very beginning of the pallet opening. As supply pressure increases, intensity increases quickly, frequency increases within a given hydrodynamic regime, and vortex noises increase as well. However, due to the existence of several hydrodynamic regimes and their instabilities, the frequency of the mouth tones can jump to a lower value whilst pressure keeps on increasing.
5. When frequencies are close, a mouth tone can stabilise very briefly on one of the pipe modes resonance, its perceptive importance being thus emphasized, ("chirp, ping") even if the transient is very short. In order to make the phenomenon more clearly audible, the pressure rise time can be stretched over several seconds. This phenomenon is reversible and can also be heard when the pressure slowly

decreases: if one key remains depressed while turning off the air supply of the organ; the pipe "cheeps", as well known to organists.

6. Mouth tones can hit one or several high rank resonant modes, especially when they have many high pitch components and when the pipe proportions give rise to quasi harmonic resonances (fine scaled pipe, large length to diameter ratio).
7. In most cases, mouth tones vanish at the onset of the steady state regime. In other cases (e.g. in Figure 4) mouth tones survive a short while (20 ms to 40 ms) during the build up of the steady state regime. In the latter case, tones can be created by combination of the main mouth tone with the first harmonics of the pipe, revealing non linearity in the excitation system.
8. The coexistence of mouth tones stabilized on inharmonic partials of the pipe with steady state harmonic series, that is, the coexistence of two different regimes can last during the whole tone. This paradoxical regime is sought for in some narrow scaled organ pipes (gambas).

4.2. Comparison with experimental results from literature

4.2.1. On the nature of forerunners

Mouth tones are mentioned by several authors who either used words that bring to the mind the anticipatory function of mouth tones: "precursor, forerunner, Vorlauferton", [1, 30, 14], or onomatopoeia that imitate their quasi- percussive high spectrum content: "chiff, chirp, ping, spitz" [13, 11]. Nolle and Finch [14] carried out several experiments to find out the nature of the forerunners that appear in pipe sounds

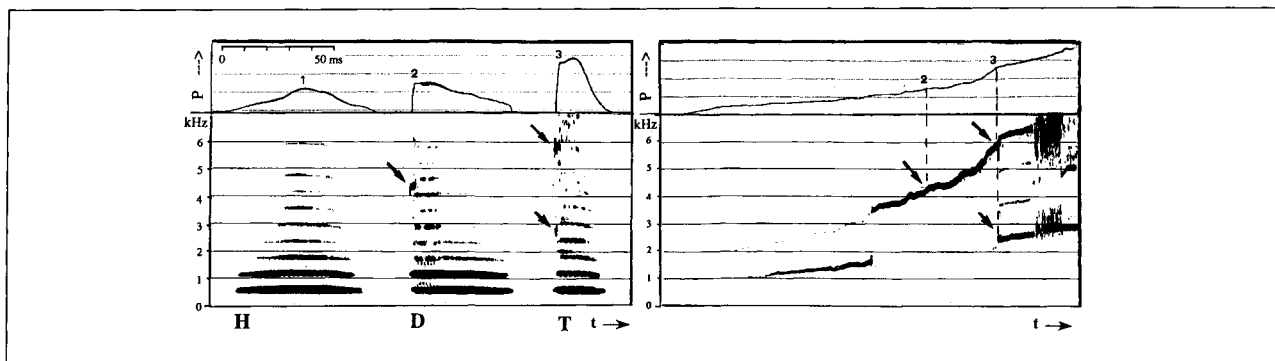

Figure 14. Alto recorder No1 played by a musician. Upper part: pressure variations in the mouth of the musician; lower part: time/frequency analysis of the sound. Left: complete flute ($A + B$), fingering D5. The note is repeated three times with three different tonguing, H, D, T. Arrows indicate the main mouth tones. Right: edge tones for part (A) alone, played with increasing pressure. Arrows indicate the frequencies corresponding to the initial pressures 2 and 3 of tonguing D and T from left hand side.

at a frequency equal to 4 or 5 times the fundamental frequency. They noticed that forerunners survive the following modifications:

- disconnecting the pipe from the mouth by filling it with absorbing material;
- leaving the pipe open, or stopping it;
- substituting a cylindrical pipe by a parallelepipedic pipe, the mouth being left unchanged.

On the other hand, the forerunner is modified when a reflecting plate is positioned on the rear wall of the mouth.

These four observations do not contradict the hypothesis stating that forerunners are produced by the mouth operating in an hydrodynamic regime. It seems therefore paradoxical that Nolle and Finch did not find any agreement between the forerunner frequencies and the edge tones frequencies of the mouth disconnected from the pipe. The main reason is, according to our interpretation, that they used a pipe with an adjustable mouth. Any change in the distance between the flue exit and the labium, and, even more critical, any change in the width of the flue, has a drastic influence on the edge tones: their frequencies and their stabilities are altered. Nolle and Finch explain that experiments on edge tones were carried out with a mean adjustment of the mouth height, different from the adjustment used for the main experiments. As a consequence, phenomena could not be compared.

Fletcher also mention the “chiff” of baroque voicing but doesn’t describe it because the pipe he used did not produce it. He therefore assumed an “underblown” regime without further justification.

4.2.2. Forerunners and pipe resonances

Contrary to Nolle and Finch’s statement [14], the mouth tone forerunner stabilizes on one of the resonant frequency of the pipe, whenever it stabilizes (e.g. in Figure 9). This is particularly noticeable when modes are highly inharmonic as for some chimney pipes, or for fork fingerings on recorders.

4.2.3. Slope variation of pressure build-up

Our experiment on slope variation of the pressure build-up in the foot of an organ pipe (see Section 3.4) is in good agree-

ment with Nolle and Finch’s results. Mouth tones are most noticeable for intermediate rise times, that is, neither too short nor too long. When transients are slow, a first regime progressively sets up without forerunner because edge tones either are too weak or have too low frequencies. When transients are plosive, the pressure quickly reaches a very high level, corresponding to edge tones that sound like band-pass noise. The steady state regime (either 1st or 2nd mode, according to pipe adjustment) starts very quickly, within a few periods. Between these two extremes, a great variety of attack transients can be achieved, depending on the spectral contents of the mouth tones and the slope of the pressure build-up. Remember that the rise time of the tone in the pipe does not stand in one to one correspondence with the rise time of the pressure in the foot.

5. Mouth tones and aesthetic conceptions

5.1. Recorders

Mouth tones give spice to the sound of recorders. On this instrument, the musician can only modify the sound by modifying the pressure in the mouth. Whereas the mean static pressure that adjusts the tone pitch must be realised with precision, different ways to reach this pressure give rise to all sorts of variants whenever allowed for by the musical quality of the mouth. After learning several types of tonguing, the recorder player may produce a great variety of timbres during the attack transients. It becomes thus understandable that the art of recorder playing, as taught in the old treatises [33], is first of all an art of tonguing based on uttering consonants. As a matter of fact, this is an excellent method for learning to adjust the shape and the rise time of the pressure build-up. Figure 14 presents three different tonguings on the experimental recorder, corresponding to consonants H, D and T respectively. The pressure curves measured in the mouth of the musician are plotted in the upper part of Figure 14. The arrival times for the harmonics and the mouth noises are displayed on time/frequency plots below. T is a fast transient with a high pressure peak, and D is softer. The mouth tone

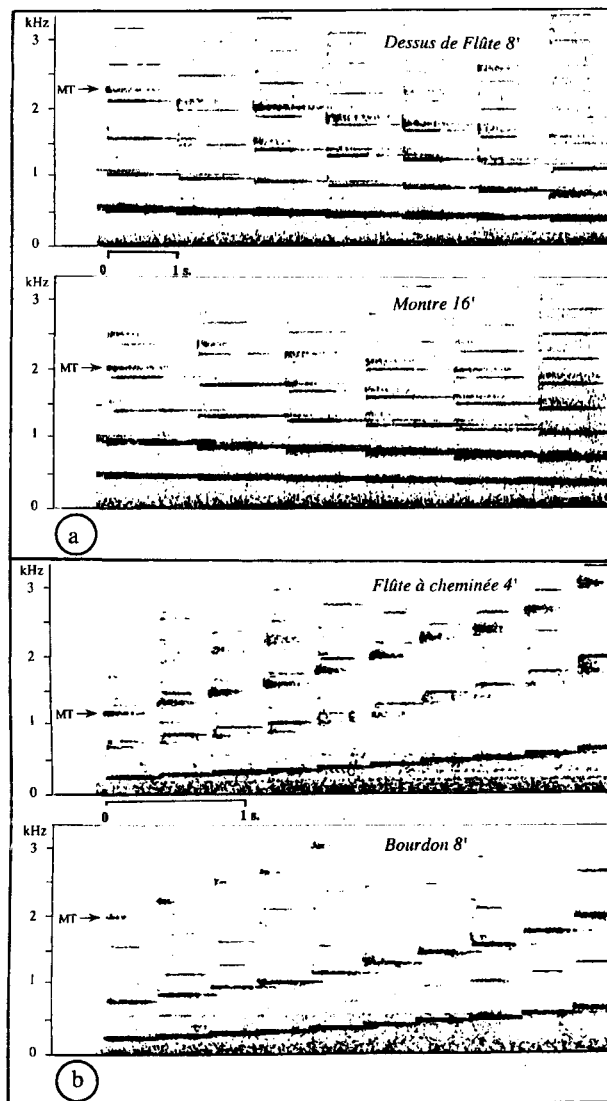

Figure 15. Analysis of some organ stops. a) Isnard Organ (1774) Saint-Maximin du Var: fragments of descending chromatic scales. Montre 16' (great organ): 1st note is the 5th C on keyboard; Dessus de flûte 8' (positive organ): 1st note is the 4th D on keyboard. b) Chamber organ by Ph. Hartman, Paris: fragments of ascending diatonic scales. Flûte à cheminée 4': 1st note is the 4th C on keyboard; Bourdon 8': 1st note is the 3rd C on keyboard. In this compass, the later stop consists in chimney pipes.

corresponding to T is also higher in pitch than the mouth tone corresponding to D. Lastly, the very progressive attack transient obtained with H eliminates mouth tones, as was already noticed in Figure 13a: it considerably alters the sound colour of the recorder. After taking apart the body, edge tones were produced on the mouth piece only, (part (A)), using a steadily increasing pressure. Initial pressure values for attacks D and T are marked on the pressure curves for part (A) only (points 2 and 3). As one can expect, edge tone frequencies are similar to the mouth tone frequencies from attacks D and T (arrows in Figure 14)

5.2. Organs

Voicing organs has been a matter of heavy discussions for centuries. The art of adjusting attack transients for organ pipes must be considered in the perspective of auditory perception and musical aesthetics. Relying on his hearing, the voicer does not adjust basses like uppers. In a similar way, transients for solo stops and transient for combined stops are balanced differently. For romantic organs where stops must blend together, mouth tones must disappear and voicers have taken the habit to cut small nicks in the flue. On the other hand, some stopped-pipes and chimney pipes take their particular charm from the very brief transients and the subtle inharmonicity of their mouth tones.

Under contract from the French Ministry of Culture, we have studied many historic organs registered as national treasures. We have noticed the importance that the mouth tones play for the precision and the sound quality of the attack transients of these instruments. For example, Figure 15 exhibits the spectrum of a few notes from two stops of the Isnard organ (1774) at Saint Maximin du Var (France). The attack of the "Dessus de Flûte" stop displays mouth noise that hits the 4th partial of the pipe, slight above the 4th harmonic. More complex mouth noises, close to the 4th and 5th harmonics, are found for the *Montre 16'* stop. The latter also presents much higher pitch attack noises, around 4000 and 5000 Hz [34]. Notice that in these two stops, the main mouth tone subsists during the steady tone as a narrow band of noise. Analysing tones recorded in a church do not accurately account for mouth tones, due to the distance between the microphone and the instrument, and due to the reverberation. Moreover, mouth tones vary statistically over several notes, and the compressed time scale, necessary to display such a scattering, often wipes it off completely on our Sona-Graph.

Two other analyses are presented in Figure 15 concerning a small chamber organ made by Ph Hartman. Notice the very intense mouth tones of the *Flûte à cheminée 4'* (chimney pipe), with frequencies just below the 5th harmonics: the whole tinkles like small bells. It is therefore of the utmost importance to precisely discriminate the mouth tone frequency from the 5th harmonic. The second series of mouth tones, located below the 3rd harmonics, are difference tones produced when the fundamentals set in. At the same pitch, the tones from *Bourdon 8'* are in fact, in this part of the compass, produced by chimney pipes which have different ratio than the *Flûte à cheminée 4'*. Mouth tones are located between the 7th and the 8th harmonics. On this small instrument with a touch sensitive keyboard, mouth tones are more prominent when playing precisely and detached. Spectra are also modified when playing legato. Most likely, too intense mouth tones are hindering the onset of some harmonics. Just like edge tones, mouth tones are very sensitive to the very small pressure variations that take place in the note channel when a given note is repeated. The human ear immediately notices changes in sound colour when a mouth tone hits a higher or a lower partial. The sound of organ pipes voiced according to the baroque style is thus enlivened in a highly unpredictable manner. If, as some wish it, the organist should have complete

control over the attack transients, not only the pallets should be equipped with an opening system very accurately controlled by the keyboard, but also and above all, they should be fed with independent air supplies.

6. General conclusion

A complete description of the attack transients of flue pipes must not only take into account the successive arrival times of the harmonics and their amplitude rise times, which have been almost exclusively studied in previous publications, but also the sound produced by the excitation system operating in its mouth regime, which plays a major role in the qualitative appreciation of the transients. Mouth tones precede the build-up of the regular regime of the flue pipe. Upon their shapes and their frequency contents depend the total durations of the transients, as well as, sometimes, the spectral contents of the steady state sounds. The survival of mouth tones during the regular regime, which until now has escaped the attention of theoreticians, is a fact attested by musical practice. Flue pipe theory must now account for such observations.

Acknowledgement

The author thanks A. Hirschberg for his encouraging and critical discussions that led to the present work; X. Boutillon, B. Fabre, V. Gibiat, M. P. Verge, C. Valette and J. D. Polack, who attentively read the manuscript, for fruitful remarks; and J. D. Polack for his patient assistance in translating the French original.

Sound examples related to the Figures 1, 2, 4, 6, 10, 11, 12, 15 are available from the author on request.

References

- [1] A. T. Jones: Recent investigations of organ pipes. *J.A.S.A.* **11** (1939) 122–128.
- [2] F. Trendelenburg, E. Thienhaus, E. Franz: Klangeinsätze an der Orgel (the onset of sound in an organ). *Akustische Zeitschrift* **1** (1936) 59–76 and **3**, 7 (1938) and **5**, 309 (1940).
- [3] D. M. A. Meerker: The tone quality of organ flue pipes and its dependance on voicing adjustments. Dissertation. London, 1959.
- [4] A. Rakowski, E. G. Richardson: Eine Analyse des Intonierungsvorganges bei Orgeln. *Gravesaner Blätter* **IV** (1960) (15–16), *Experimental Studio*, Gravesano (Suisse), 46–53.
- [5] J. S. Keeler: The attack transients of organ pipes. *IEEE Trans. AU* **20** (1972) 378.
- [6] J. Angster, A. Miklos: New developments on the understanding of the buildup of organ sounds. 13th ICA, Belgrade, 1989. 99–102.
- [7] J. Angster, J. Angster, A. Miklos: Über die Messungen während des Intonationsprozesses bei Lippenpfeifen der Orgel. *Instrumentenbau Zeitschrift* **7/8** (1991) 71–76.
- [8] J. Angster, A. Miklos: Transient sound spectra of a variable length organ pipe. *International Symposium on Musical Acoustics*, Tokyo, 1992. 159–162.
- [9] J. Angster, G. Paal, W. Garen, A. Miklos: Effect of voicing steps on the stationary spectrum and attack transient of a flue organ pipe. *Proc. of the International Symposium on Musical Acoustics*, Edinburgh, 1997. 285–294.
- [10] N. H. Fletcher: Transients in the speech of organ flue pipes - A theoretical study. *Acustica* **34** (1976) 224–233.
- [11] N. H. Fletcher: Sound production by organ flue pipes. *J.A.S.A.* **60** (1976) 926–936.
- [12] A. W. Nolle, C. P. Boner: The initial transients of organ pipes. *J.A.S.A.* **13** (1941) 149–155.
- [13] A. W. Nolle: Some voicing adjustments of flue organ pipes. *J.A.S.A.* **66** (1979) 1612–1626.
- [14] A. W. Nolle, T. L. Finch: Starting transients of flue organ pipes in relation to pressure rise time. *J.A.S.A.* **91** (1992) 2190–2202.
- [15] M. P. Verge, B. Fabre, W. Mahu, A. Hirschberg, R. van Hassel, A. Wijnands, J. de Vries, H. C.: Jet formation and jet velocity fluctuations in a flue organ pipe. *J.A.S.A.* **95** (1994) 1119–1132.
- [16] M. P. Verge, B. Fabre, A. Hirschberg, P. Wijnands: Sound production in recorderlike instruments. I. Dimensionless amplitude of the internal acoustic field. *J.A.S.A.* **101** (1997) 2914–2924.
- [17] M. P. Verge, A. Hirschberg, R. Caussé: Sound production in recorderlike instruments. Part II. A simulation model. *J.A.S.A.* **101** (1997) 2925–2939.
- [18] A. Powell: On the edgetone. *J.A.S.A.* **33** (1961) 395–409.
- [19] S. Yoshikawa, J. Saneyoshi: Feedback excitation mechanism in organ pipes. *J. Acoust. Soc. Jpn (E)* **1** (1980) 175–191.
- [20] W. Mahu, M. Peters, V. M. P. et al.: Attack transients of a flue organ pipe. 2nd Dutch Conference on Mechanics, 1992.
- [21] M. P. Verge, R. Schoffelen, A. Wijnands, H. A., C. Box: Acoustic behavior of chimney pipes. *ISMA 97*, Edinburgh, 1997.
- [22] E. Leipp: Quelques méthodes et problèmes de l'acoustique. *Annales de l'Université de Paris* **23** (1968) 233–245.
- [23] F. Winckel: Vues nouvelles sur le monde des sons. French translation from "Klangwelt unter der Lupe". M. Hesses Verlag, Berlin, 1952.
- [24] M. Castellengo: Contribution à l'étude expérimentale des tuyaux à bouche. Dissertation. Université de Paris VI, 1976.
- [25] Z. Carriere: Harmoniques supérieurs des tuyaux à bouche de flûte, par vent très faible. *Journal de Physique et le Radium*, Paris (1926) 7–12.
- [26] H. Bouasse: Instruments à vent, T.1, §97. Delagrave, Paris, 1929.
- [27] W. K. Blake, A. Powell: The development of contemporary views of flow-tone generation. – In: *Recent advances in aeroacoustics*. Springer Verlag, New York, 1983.
- [28] M. Castellengo: Spectrographie des transitoires d'attaque des tuyaux à embouchure de flûte. 8th ICA, Londres, 1974.
- [29] M. Castellengo: The role of mouth-tones in the constitution of attack transients of mouth pipes. *Forum Acusticum*, Antwerpen, 1996.
- [30] W. Lottermoser: *Orgel, Kirchen und Akustik*. Verlag E. Bochinsky, Frankfurt/Main, 1983, Vol II, 23, et Vol I, 63–64.
- [31] T. L. Finch, A. W. Nolle: Pressure wave reflections in an organ note channel. *J.A.S.A.* **79** (1986) 1584–1591.
- [32] M. Castellengo: Etude acoustique des orgues italiens de la vallée de la Roya. *L'orgue Italien, Cahier des Alpes-maritimes*, No.7, Nice, 1990.
- [33] S. Ganassi: *Opera intitulata Fontegara, la quale insegna a sonare di flauto*. Venise, Fac simile, Bollet/ Bibl. mus., Milano, 1934.
- [34] M. Castellengo: Analyses spectrographiques de quelques jeux d'un orgue. *La revue Musicale*, Paris **295-296** (1977) 103–111.